





| TOMAS Y ENCHUFES INDUSTRIALES (MODELO P17) TIPO 6 HORAS | | | |
|---|------------|--------------|--|
| ENCHUFES- CLAVIJAS | | | |
| | COD. SCAME | COD. LEGRAND | DESCRIPCION |
| | 2131633 | 57424 | MONOFAS., AZUL, 6H, 16A/250V, 2P + T, IP 44 |
| | 2133233 | 58124 | MONOFAS., AZUL, 6H, 32A/250V, 2P + T, IP 44 |
| | 2131636 | 57438 | TRIFAS., ROJO, 6H, 16A/440V, 3P + T, IP 44 |
| | 2133236 | 58138 | TRIFAS., ROJO, 6H, 32A/440V, 3P + T, IP 44 |
| | 2186336 | 58704 | TRIFAS., ROJO, 6H, 63A/440V, 3P + T, IP 66/67 |
| | 21812536 | 59126 | TRIFAS., ROJO, 6H, 125A/440V, 3P + T, IP 66/67 |
| | 21863367 | | TRIFAS., NEGRO 5H, 63A/550V, 3P + T, IP 66/67 |

| TOMAS SOBREPUESTAS-MURAL | | | |
|--------------------------|------------|--------------|---|
| | COD. SCAME | COD. LEGRAND | DESCRIPCION |
| | 5131653 | 55353 | MONOFAS., AZUL, 6H, 16A/250V, 2P + T, IP 44 |
| | 5133253 | 55373 | MONOFAS., AZUL, 6H, 32A/250V, 2P + T, IP 44 |
| | 5131656 | 55557 | TRIFAS., ROJO, 6H, 16A/440V, 3P + T, IP 44 |
| | 5133256 | 55577 | TRIFAS., ROJO, 6H, 32A/440V, 3P + T, IP 44 |
| | 5156356 | 58744 | TRIFAS., ROJO, 6H, 63A/440V, 3P + T, IP 66/67 |
| | 51512556 | 59106 | TRIFAS., ROJO, 6H, 125A/440V, 3P+T, IP 66/67 |
| | 5186356T | | BASE MURAL 3P+T 63AMP 6H |

TOMAS EMPOTRABLES

| | COD. SCAME | COD. LEGRAND | DESCRIPCION |
|---|-------------------|---------------------|---|
|  | 4131663 | 57364 | MONOFAS., AZUL, 6H, 16A/250V, 2P + T, IP 44 |
| | 4133263 | 57612 | MONOFAS., AZUL, 6H, 32A/250V, 2P + T, IP 44 |
|  | 4131666 | 57617 | TRIFAS., ROJO, 6H, 16A/440V, 3P + T, IP 44 |
| | 4133266 | 57618 | TRIFAS., ROJO, 6H, 32A/440V, 3P + T, IP 44 |
| | 4186366 | 58724 | TRIFAS., ROJO, 6H, 63A/440V, 3P + T, IP 66/67 |
| | 41812566 | 59116 | TRIFAS., ROJO, 6H, 125A/440V, 3P+T, IP 66/67 |

TOMAS EXTENSION (PROLONGADORES)

| | COD. SCAME | COD. LEGRAND | DESCRIPCION |
|---|-------------------|---------------------|---|
|  | 3131643 | 57504 | MONOFAS., AZUL, 6H, 16A/250V, 2P + T, IP 44 |
| | 3133243 | 58204 | MONOFAS., AZUL, 6H, 32A/250V, 2P + T, IP 44 |
| | 3131646 | 57518 | TRIFAS., ROJO, 6H, 16A/440V, 3P + T, IP 44 |
| | 3133246 | 58218 | TRIFAS., ROJO, 6H, 32A/440V, 3P + T, IP 44 |
|  | 3186346 | 58714 | TRIFAS., ROJO, 6H, 63A/440V, 3P + T, IP 66/67 |
| | 31812546 | 59136 | TRIFAS., ROJO, 6H, 125A/440V, 3P+T, IP 66/67 |
| | 31863467 | | TRIFAS., NEGRO, 5H, 63A/550V, 3P+T, IP 66/67 |

BORNE DE CONEXIÓN

| | CODIGO | DESCRIPCION |
|---|---------------|----------------------------------|
|  | 810372/TR | BORNE DE CONEXIÓN 1.5MMQ 450V AC |
| | 810374/TR | BORNE DE CONEXIÓN 2.5MMQ 450V AC |
| | 810375/TR | BORNE DE CONEXIÓN 4MMQ 450V AC |
| | 810376/TR | BORNE DE CONEXIÓN 6MMQ 450V AC |
| | 810378/TR | BORNE DE CONEXIÓN 10MMQ 450V AC |
| | 810379/TR | BORNE DE CONEXIÓN 16MMQ 450V AC |

| CUADRO DE DISTRIBUCION, SERIE ENERBOX, IP55 | | |
|---|---------|---|
| | CODIGO | DESCRIPCION |
|  | 6331010 | 285X145X107mm, PANEL CIEGO, HASTA 6 MODULOS RIEL DIN |
| | 6332020 | 285X235X107mm, PANEL CIEGO, HASTA 11 MODULOS RIEL DIN |

| CUADRO DE DISTRIBUCION, SERIE BLOCK, IP66 | | |
|---|------------|--|
| | CODIGO | DESCRIPCION |
|  | 6323510000 | BLOCK 3, 136X440X114mm, PANEL CIEGO, HASTA 6 MODULOS RIEL DIN |
| | 6324510000 | BLOCK 4, 212X415X114mm, PANEL CIEGO, HASTA 10 MODULOS RIEL DIN |
| | 6325510 | BLOCK 5, 272X414X110mm, PANEL CIEGO, HASTA 14 MODULOS RIEL DIN |

| ENROLLACABLES | | |
|---|---------|--|
| | CODIGO | DESCRIPCION |
|  | SC92062 | ENROLLACABLE CON DISCO CIEGO PARA ADICION DE TOMAS (SC92068) |





| PRENSA CABLE ANTITIRÓN IP66 | | |
|---|---------|-------------------------------|
| | CODIGO | DESCRIPCION |
|  | 8053342 | PRENSA ESTOPA PG 11 (ø19mm) |
| | 8053343 | PRENSA ESTOPA PG 13.5 (ø21mm) |
| | 8053344 | PRENSA ESTOPA PG 16 (ø23mm) |
| | 8053345 | PRENSA ESTOPA PG 21 (ø29mm) |
| | 8053346 | PRENSA ESTOPA PG 29 (ø37.5mm) |
| | 8053347 | PRENSA ESTOPA PG 36 (ø47.5mm) |
| | 8053348 | PRENSA ESTOPA PG 42 (ø54.5mm) |
| | 8053349 | PRENSA ESTOPA PG 48 (ø60mm) |

| | CODIGO | DESCRIPCION |
|---|---------|-----------------------------------|
|  | 8057341 | PRENSA ESTOPA PG 3/8" (ø16mm) |
| | 8057343 | PRENSA ESTOPA PG 1/2" (ø21mm) |
| | 8057344 | PRENSA ESTOPA PG 5/8" (ø23mm) |
| | 8057345 | PRENSA ESTOPA PG 3/4" (ø29mm) |
| | 8057346 | PRENSA ESTOPA PG 1" (ø37.5mm) |
| | 8057348 | PRENSA ESTOPA PG 1-1/2" (ø47.5mm) |
| | 8057349 | PRENSA ESTOPA PG 2" (ø60mm) |

| CAJA PARA ELEMENTOS DE 22MM IP65 | | |
|--|----------|-----------------------------|
| | CODIGO | DESCRIPCION |
|  | 590PR01K | CAJA PLASTICA DE 1 ELEMENTO |
| | 590PR02K | CAJA PLASTICA DE 2 ELEMENTO |
| | 590PR03K | CAJA PLASTICA DE 3 ELEMENTO |

| CAJA DE DISTRIBUCIÓN | | |
|---|---------|--|
| | CODIGO | DESCRIPCION |
|  | 6570038 | CAJA DISTRIBUCION VACIO PARA ARMARIOS ELECTRICOS |

| CONMUTADORES SECCIONADORES | | |
|---|-----------|------------------------------|
| | CODIGO | DESCRIPCION |
|  | 590YA633B | CONMUTADOR 0-1 DE 63 AMP 3 P |

| CONMUTADORES MANUALES EN PARALELO | | |
|---|------------|--|
| | CODIGO | DESCRIPCION |
|  | 590KS400MA | CONMUTADOR MANUAL DE 400 AMP 3P |
| | 590KS630MA | CONMUTADOR MANUAL DE 630 AMP 3P |
| | 590KS800MA | CONMUTADOR MANUAL DE 800 AMP (50kA) 3P |



CONMUTADORES MOTORIZADOS

| CODIGO | DESCRIPCION |
|-------------|--|
| 590KS800MO | CONMUTADOR MOTORIZADO DE 800 AMP (50kA) 3P KS5 |
| 590KS1000MO | CONMUTADOR MOTORIZADO DE 1000 AMP (50kA) 3P |
| 590KS1250MO | CONMUTADOR MOTORIZADO DE 1250 AMP (50kA) 3P |
| 590KS1600MO | CONMUTADOR MOTORIZADO DE 1600 AMP (50kA) 3P |
| 590KS2000MO | CONMUTADOR MOTORIZADO DE 2000 AMP (50kA) 3P |
| 590KS2500MO | CONMUTADOR MOTORIZADO DE 2500 AMP 3P KS6 |



INTERRUPTORES SECCIONADORES PARA RIELDIN



| CODIGO | DESCRIPCION |
|-----------|------------------------------------|
| 590YA163B | CUERPO SECCIONADOR 3P 0-1 DE 16AMP |
| 590YA203B | CUERPO SECCIONADOR 3P 0-1 DE 20AMP |
| 590YA323B | CUERPO SECCIONADOR 3P 0-1 DE 32AMP |
| 590YA403B | CUERPO SECCIONADOR 3P 0-1 DE 40AMP |
| 590YA803B | CUERPO SECCIONADOR 3P 0-1 DE 80AMP |





CONMUTADORES PARA PUERTAS

| CODIGO | DESCRIPCION |
|------------|--|
| 590YA403R | CUERPO INT. MANIOBRA 40A 3P R |
| 590YA633R | CUERPO INT. TRANSCUAD. MANIOBRA 63A 3P R |
| 590YA803R | CUERPO INT. MANIOBRA 80A 3P R |
| 590YA1003R | CUERPO INT. MANIOBRA 100A 3P R |



| MANDO FRONTAL | | |
|---|-----------|--|
| | CODIGO | DESCRIPCION |
|  | 590YM67B1 | MANDO FRONTAL DE 13-32-40AMP |
| | 590YM67B7 | MANDO FRONTAL DE 63-80-100AMP |
|  | 590YM67R1 | MANDO FRONTAL 16A 32A 40A 67x67mm IP65 R |
| | 590YM67R6 | MANDO FRONTAL 63A 80A 100A 67x67mm IP65 |

| | CODIGO | DESCRIPCION |
|---|-----------|---------------------------------|
|  | 590YMA085 | PROLONGACIÓN 16-32-40AMP 85mm |
| | 590YMB185 | PROLONGACIÓN 63-80-100AMP 185mm |

| | CODIGO | DESCRIPCION |
|---|-------------|---|
|  | 590PL004001 | CONTACTO NC PARA RIEL DIN Y PUERTA, SECCIONADOR HASTA 40AMP |
| | 590PL004002 | CONTACTO NO PARA RIEL DIN Y PUERTA SECCIONADOR HASTA 40AMP |
| | 590PL004003 | CONTACTO NC PARA RIEL DIN Y PUERTA SECCIONADOR HASTA 100AMP |
| | 590PL004004 | CONTACTO NO PARA RIEL DIN Y PUERTA SECCIONADOR HASTA 100AMP |

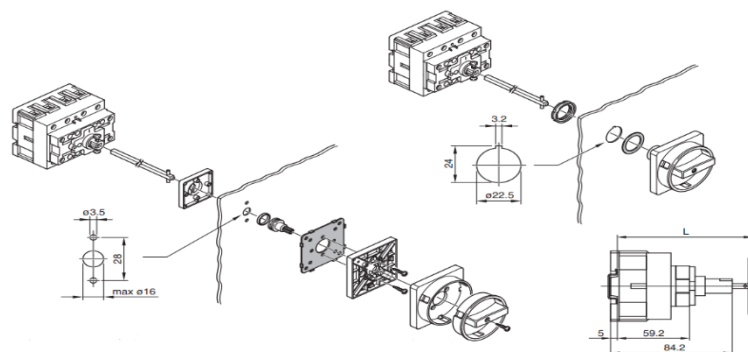

| CAJA DE DERIVACIÓN IP55 GW 650°C | | |
|---|---------|---|
| | CODIGO | DESCRIPCION |
|  | 686206 | CAJA PLASTICA SIN CONOS 150x110x70mm |
| | 686207 | CAJA PLASTICA SIN CONOS 190x140x70mm |
| | 686210 | CAJA PLASTICA SIN CONOS 380x300x120mm |
| | 686211 | CAJA PLASTICA SIN CONOS 460x380x130mm |
|  | 687004 | CAJA PLASTICA 100x100x50mm CON 7 CONOS PG21 |
| | 687005 | CAJA PLASTICA 120x180x50mm CON 6 CONOS PG21 |
| | 687006 | CAJA PLASTICA 150x110x70mm CON 10 CONOS PG21 |
|  | 685007 | CAJA PLASTICA 190x140x70mm CON 10 CONOS Y PUERTA PG29 |
| | 685008 | CAJA PLASTICA 240x190x90mm CON 12 CONOS Y PUERTA PG29 |
| | 685009 | CAJA PLASTICA 300x220x120mm CON 12 CONOS Y PUERTA PG29 |
| | 685010 | CAJA PLASTICA 380x300x120mm CON 12 CONOS Y PUERTA PG36 |
|  | 685011 | CAJA PLASTICA 460x380x130 mm CON 12 CONOS Y PUERTA PG36 |
| | 6540023 | KIT OREJAS DE FIJACION MURAL PARA CAJA 685011 |
|  | 6540085 | KIT BISAGRAS PARA CAJAS PLASTICAS CON PUERTA |